

ZANUSSI

**Instructions
for the use and care
of FB 550 Cuisinair
built-in double oven**

Contents

Building-in	Page 3
Connecting to electricity	Page 5
Use and Care	Page 6
Using the upper oven	Page 8
Using the lower oven	Page 10
Using the grill	Page 12
Cleaning	Page 14
What happens if something goes wrong	Page 15

Important: The installation of the oven and connecting it to electricity must always be done by competent installers to standards and regulations currently in force.

Building-in

It is important that the dimensions and materials of the surround or cabinet into which the oven will be built are correct and that proper arrangements are made for a continuous supply of air to the oven so it does not overheat.

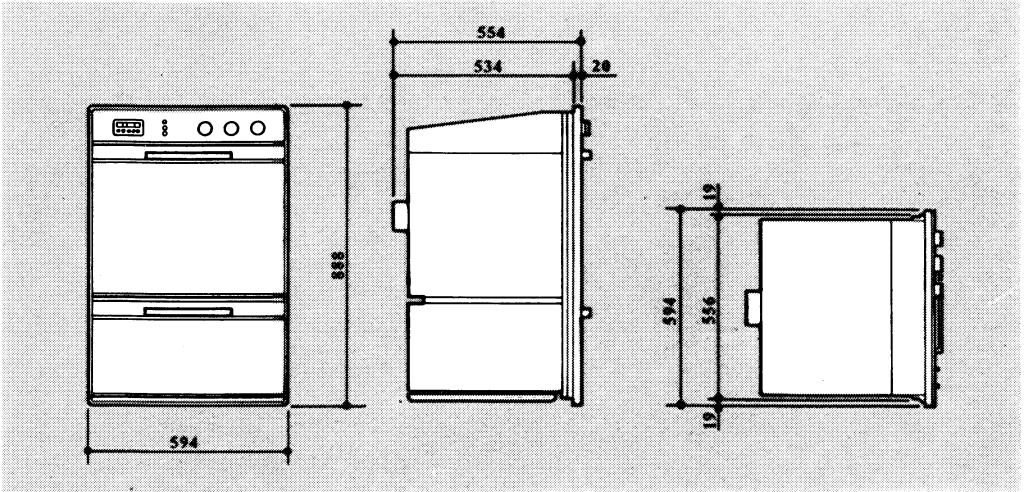

fig. 1

Dimensions of the recess for building into a kitchen unit.

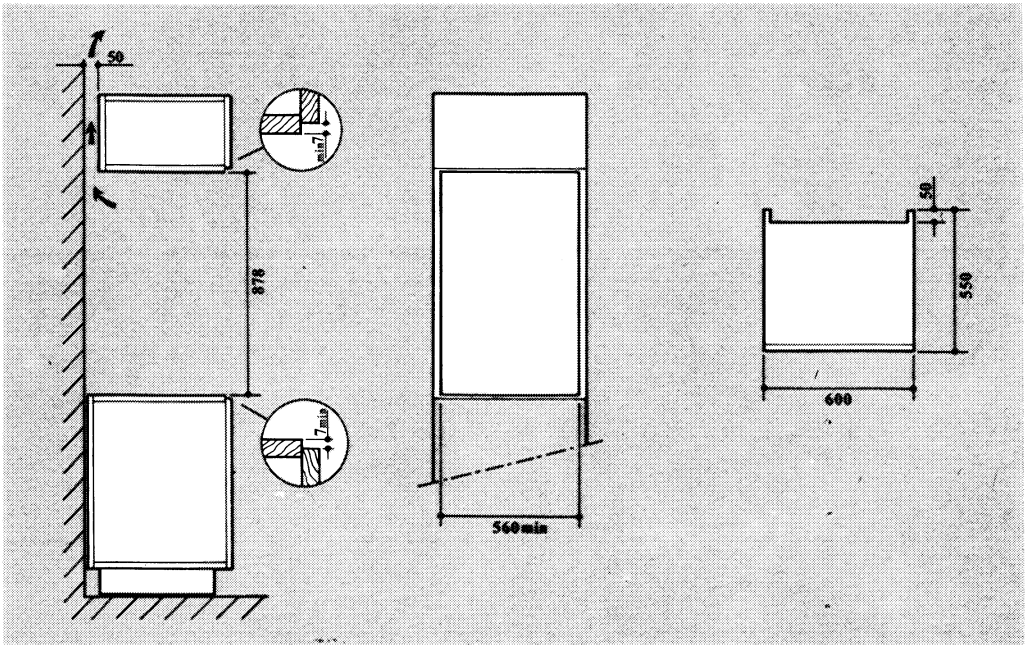

fig. 2

Important

To ensure an efficient ventilation, it is necessary to leave the vents provided at the bottom of the oven clear, and for this purpose it is advisable to make a suitable groove in the board or shelf supporting the oven.

Fig. 3 illustrates the ideal solution.

Securing the oven to the cabinet

Fit the appliance into the cabinet recess. Open the oven door and secure the oven to the kitchen cabinet with six wood screws which fit exactly the holes provided in the oven frame (Fig. 4).

Cooling fan

The cooling fan is designed to cool the sides and the components of the oven itself.

The fan switches on automatically when the oven control knob is turned on.

Warm air is blown out through the aperture above the upper oven door handle.

When the oven is switched off, the fan may remain on for several more minutes in order to cool the oven and kitchen units properly, after which it switches off automatically.

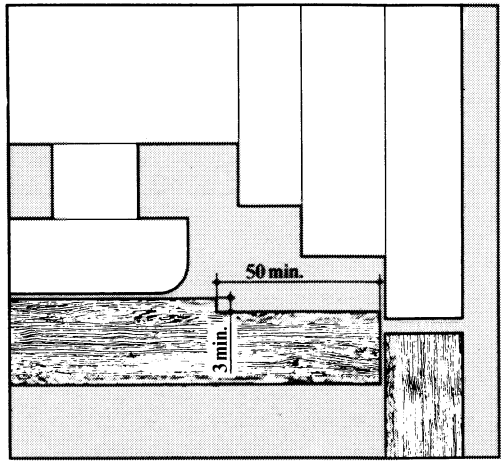

fig. 3

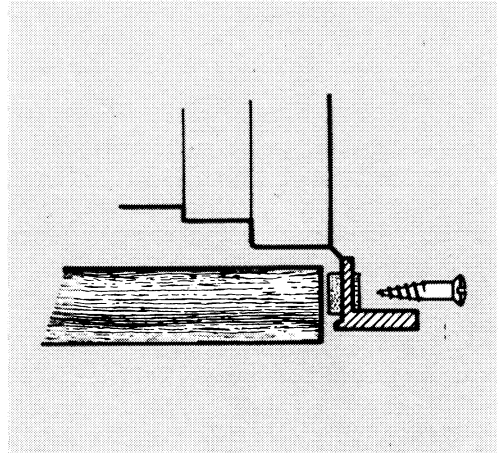

fig. 4

Connecting to electricity

The oven is designed to be connected to 240V - 50Hz electricity supply.

The upper oven has a heating element rated at 2500 W.

The lower oven ratings are as follows:

Lower element	1000 W
Upper element	1000 W
Grill element	2000 W

The oven has an easily accessible terminal block which is marked as follows:

Letter L	Live terminal
Letter N	Neutral terminal
\perp	Earth

The cable used must be of the three core type with a cross section of 2,5 mm².

In order to connect it to the oven it is necessary to remove the hatch at the back of the oven to reach the terminal block.

For direct connection to the mains supply a two pole switch with a minimum rating of 19 A and a minimum distance of 3 mm between its contacts must be fitted between the supply and the appliances.

This switch must not break the green/yellow cable at any point.

The manufactures disclaim any responsibility should these safety instructions not be carried out.

The appliance meets the requirements laid down in EEC Directive No 76/889 dated 4/11/1976 relating to the suppression of radio and TV interference.

The appliance must be earthed

Important: After installation and connection the cable must be placed so that it cannot at any point reach a temperature of more than 50°C above the ambient temperature.

Before the appliance is connected check that:

the main fuse and the domestic installation can support the load;
the power supply is properly earthed;
the two pole switch used to connect the appliance to the supply is easily accessible after installation.

Use and care

The internal dimensions are:

	Top oven	Bottom oven
Height	330 mm	200 mm
Width	420 mm	425 mm
Depth	378 mm	385 mm
Capacity	52 litres	32,5 litres

When the appliance is first installed

Once the appliance is installed the protective materials which were put on in the factory must be removed.

The plastic film covering some external parts can be removed by wiping with a cloth dipped in methylated spirit.

Other protective materials will burn off if the controls of the ovens are turned to MAX and then it is allowed to run empty for 30 minutes.

This will also remove any unpleasant smells.

The FB550 consists of two ovens.

The upper oven is evenly heated throughout. A fan in the back wall distributes heated air round the food during cooking so that everything cooks in the same time regardless of where it is placed in the oven or how much is being cooked.

Foods of different types, provided they require the same cooking temperature, can be cooked together and there is no possibility of any flavours or smells being transmitted from one food to another. This is the Zanussi cuisinair system.

Cooking can be manual or automatic (with or without the programmer).

This includes a digital clock, a minute minder and controls by which the upper oven can be set to come on and go off unattended.

The bottom oven is a conventional one and contains a grill.

The grill control provides a variety of heat settings.

Indicator lights on the control panel show when the oven is switched on, and the behaviour of the thermostat during cooking.

A light comes on inside the oven when it is switched on and remains on until the oven goes off.

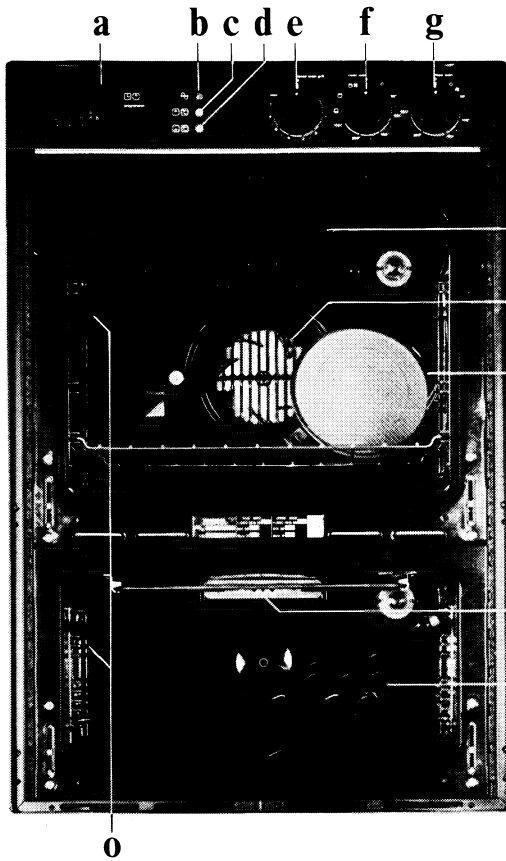

- a electronic programmer
- b ON/OFF light
- c upper oven temperature light
- d lower oven temperature light
- e grill control knob
- f lower oven control knob
- g upper oven control knob
- h removable oven liner panels
- i fan
- j removable grease filter
- k upper oven (cuisinair)
- l socket for grill element
- m removable grill element
- n lower oven
- o removable shelf runners

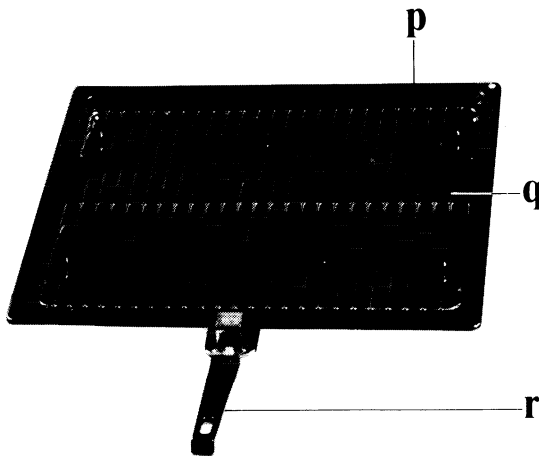

- p grill or roasting pan
- q reversible grill pan insert
- r removable handles (2 off).

fig. 5



Using the upper oven



As soon as the oven is switched on the fan starts and runs until the oven control is switched off again (Fig. 5).

Food should be put into the oven before switching on, even when cooking manually – the speed of heating up is so fast that there is no need to preheat. The oven shelves can be fully filled. Most normal types and materials of cooking utensils may be used.

During cooking, the door should be opened as little as possible to avoid heat loss and so excessive electricity consumption.

Cooking manually

When cooking manually ensure that the programmer is not in operation accidentally. Check that neither the  or  displays are on.

If either display is on and you do not want to use the automatic programmer return the control   to the manual position  (see section on the electronic programmer).

Arrange the food in the oven, shut the door and turn the oven control (see fig. 6) to the required temperature setting. When the control reaches  the oven temperature light will come on, also the internal oven light.

This setting is NOT a cooking position but is intended for gentle thawing of frozen food.

Positions from 50°C to 250°C are cooking positions and give a full range of temperatures.

The oven temperature light will come on until the oven has reached the correct temperature; after that it will come on and go off showing how the temperature is being maintained.

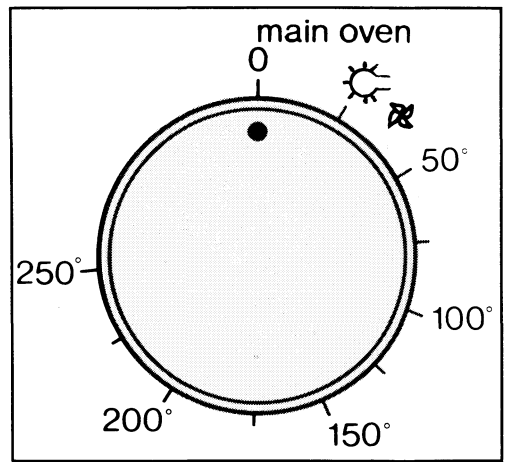

fig. 6

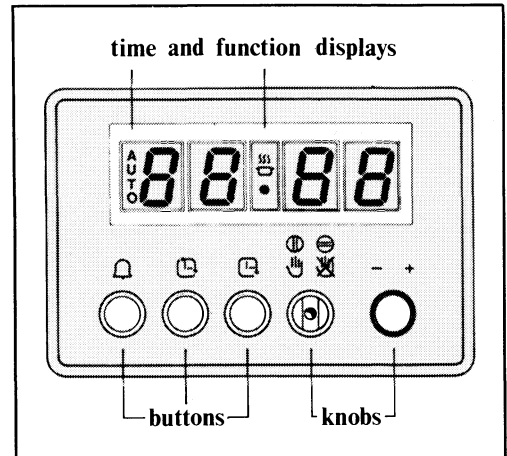

fig. 7

Cooking automatically



The upper oven cooks automatically when the programmer is set to switch it on and off at the times given without the need for anyone to be in attendance. Most foods cook well automatically but preference should be given to those which will not be affected by the waiting period before the oven comes on.

The electronic programmer (Fig. 7)





Fig. 7 illustrates the control buttons and knobs, and the various electronic displays of the programmer both for time and function.

The following table shows the functions fulfilled by each button and control knob, as well as the information supplied by the electronic display of the programmer.



Buttons Function

-  Setting or resetting the minute minder and to turn off the buzzer alarm.
-  Setting or resetting the duration of the cooking time.
-  Setting or resetting the time at which the cooking period will end.

Knobs Function

-  Setting or adjusting the clock.
-  The position for manual operation of the upper oven.
-  The position for automatic operation of the upper oven.
-  Altering the time or setting the programmer.

Function displays

- Indicates normal operation.
-  Indicates that the upper oven is programmed but not yet cooking.
- ???
-  Indicates that the upper oven is cooking by use of the automatic programmer.

Setting or adjusting the clock

The clock is a 24 hour clock and so will show the time in the afternoon and evening on the 24 hour basis i.e.: 12.00, 13.00, 14.00 etc.

When the upper oven is first connected or after resumption of power after a power failure, the digits of the clock will flash and not read the correct time.

To reset or adjust the clock follow this simple procedure:

Using a pointed object (like a pencil or match) press the small button located in the centre of the control knob  and, keeping this button depressed, turn the control knob + - in either direction until the clock displays the correct time.

Remember that it is a 24 hour clock.

When you release the button in the centre of control knob  the clock will automatically start counting.



So to obtain the most accurate time from the clock the button in control knob  should be released only at the beginning of the minute displayed on the clock otherwise it will always be either some seconds fast or slow.

Totally automatic cooking

The upper oven can be programmed to switch on and off automatically.

The maximum programmable cooking time is 5 hours and 59 minutes.



Place the food to be cooked in the upper oven and proceed as follows:

Turn the control knob  into the automatic position .

The  display will start flashing to indicate that the programmer is ready to be set.



Push button  and keeping it pressed in, set the time at which the programme is to end by turning control knob + - either way so the display shows the desired time.

Remember it is a 24 hr clock.

When the desired time is displayed release button  and the  display will stop flashing but remain on continuously to indicate that the setting is made.



Now the  display will flash to indicate that you must now set the duration of cooking required.



Push button  and keeping it pressed in, set the duration of cooking that is required by turning the control knob + - in either direction so the display shows the time required.

The maximum possible time is 5hrs 59 mins. Then release button  and the  display will turn itself off. This indicates that the programme is set and the  display remains on.

Now set the upper oven control to the desired temperature setting.

When the time is reached for the cooking to commence the  display will come on and remain on during the automatic cooking programme.

As soon as the cooking is finished the upper oven will switch off and a buzzer alarm will sound. To turn the alarm off press button . If you do not push button  the alarm will continue for 3 mins and then turn itself off automatically.



When you return to the upper oven after completion of an automatic cooking programme return the control knob   to the manual position  and return the upper oven control knob to the off position.



Semi-automatic cooking



It is also possible to start cooking immediately in the upper oven and programme the duration of cooking so the upper oven turns itself off automatically.

The maximum programmable cooking time is 5 hours and 59 minutes.



Place the food in the upper oven, and proceed as follows:

Turn the control knob   into the automatic position .

The  display will start flashing to indicate that the programmer is ready to be set. Push button  and keeping it pressed in turn the control knob + - either way so that the display shows the time at which the cooking is to end.

Now release button  and the  display will indicate that the programme is set. Turn the upper oven control knob to the desired temperature and the cooking will commence.

When the end of cooking programme is reached the oven will switch off and buzzer alarm will sound. To turn off the alarm press button . If you do not turn it off it will continue for 3 mins and then turn itself off automatically.

When you return to the upper oven after the completion of an automatic cooking programme, return the control knob   to the manual position  and return the upper oven control knob to the off position.

To use the minute minder

This is a simple timer and cannot be used at the same time as the automatic or semiautomatic cooking programme. It can be set for anything up to 5hrs59 mins.

To set it push button  and keeping it pressed in turn control knob + - so that the display shows the required time.

When the time set expires a buzzer alarm will sound.

To turn off the alarm push button . If you do not turn it off the alarm will continue for 3 mins. and then turn itself off automatically.

Using the lower oven

Preheat the oven, arrange the food in the oven, shut the door and turn the oven control (see fig. 8) to the required temperature setting. When the control reaches ☀ the oven temperature light will come on, also the internal oven light which will remain on during the whole cooking time.

Positions from 50°C to MAX are cooking positions and give a full range of temperatures.

The oven temperature light will come on until the oven has reached the correct temperature, after which it will go on and off showing how the temperature is being maintained.

When the oven control reaches ◻ the bottom element comes on and a temperature of max. 240°C can be obtained. When the oven control reaches ◻ , the top element comes on and a temperature of max. 300°C can be obtained. These settings are particularly useful for finishing food either only on the top or the bottom.

During cooking, the door should be opened as little as possible to avoid heat loss and so excessive electricity consumption.

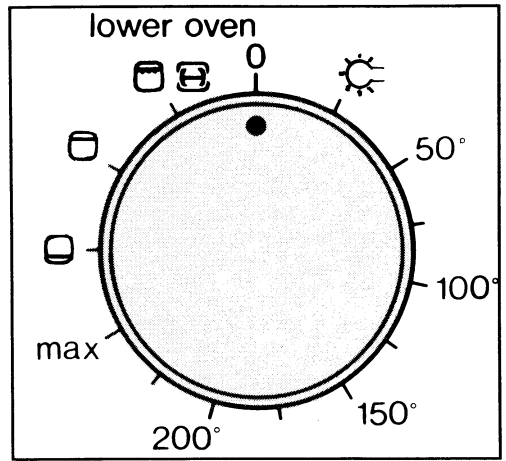

fig. 8

Using the grill

The grill is located in the lower oven. As with the ovens, the grill control can be set to a number of different heats (Fig. 9). At MAX the element stays on continuously to give the highest degree of heat.

Foods to be grilled are placed on the wire grid in the grill pan which can be curved either upwards or downwards to give the required distance from the element.

The pan is then placed in the required runner position.

Important:

Because the grill element is in the top of the lower oven, the door must be left ajar when grilling.

This means that the escaping heat from the grill could overheat the upper oven door and the control panel, so to prevent this happening it is essential that the heat deflector provided to protect the rest of the appliance is in place before the grill is switched on.

The deflector is put in place as shown in Fig. 10.

To use the grill

Open the door and put the heat deflector in position. Turn the oven control (see Fig. 8) to ☒ and then set the grill control to the heat setting required. A little use and practice will soon show which heat setting is the best for the individual user.

When grilling is over remove the heat deflector and shut the door.

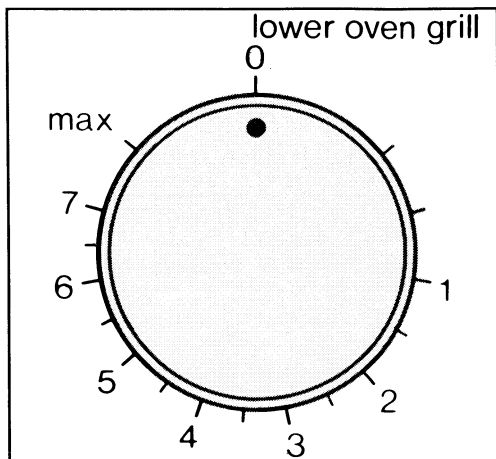

fig. 9

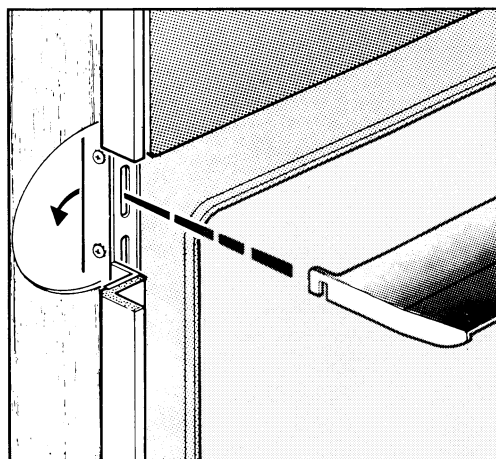

fig. 10

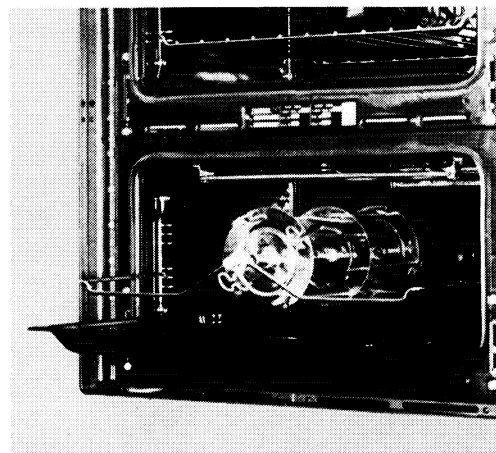

fig. 11

Using the rotisserie in the lower oven

The rotisserie can be used for either spit roasting meat or for kebabs and smaller pieces of meat.

The accessories for either are provided. If you want to spit roast a large piece of meat or poultry proceed as follows.

Firstly place one of the two prong forks onto the spit and lock it into position with the thumb nut.

Then skewer the meat or poultry onto the spit and securely onto the fork. Place the second fork onto the spit and skewer it into the meat then lock it in position with the thumb nut.

Place the spit onto the support frame and ensure it turns freely and evenly. If it does not, reposition the meat until it does. If this is not done excessive wear to the motor will result.

Place the frame and spit into the oven so the spit engages fully into the motor in the back of the oven.

Place a drip pan on a lower support. Secure the heat deflector into position (Fig. 10). Close the oven door to the ajar position and turn the lower oven control knob to the  symbol.

Should you wish to use the kebab attachments then proceed as follows. Firstly place one of the support discs with 4 elongated slots in it onto the spit and secure it by locking the thumb nuts about 1 1/2 inches from the handle of the spit.

Next place the disc with the 8 holes onto the spit and secure it in position with the thumb nut. The position of this disc can be decided by judging the distance required against the length of the individual kebab skewers.

Next place the third disc on the skewer positioning it at the same distance from the centre disc as the first one.

Lock it in position with the thumb nut.

Prepare the 8 individual kebab skewers and putting the pointed end through one of the holes on the centre disc.

Lock it in position by placing the other end in an elongated slot in one of the outer discs and turning it.

Repeat this operation for each of the 8 skewers. Place the spit onto the frame and check that it turns freely and evenly. If it does not, reposition the weight of the food until it does. If this is not done excessive wear to the motor will result. Place the frame and spit into the oven so that the spit engages fully into the motor in the back of the oven.

Place a drip pan on a lower support. Secure the heat deflector into position (Fig. 10). Close the oven door to the ajar position and turn the lower oven control knob to the  symbol.

To assist you to remove the spit after cooking an insulated screw on handle is provided for the spit (Fig. 11).

Cleaning

After every meat roasting wipe the oven panels using a damp cloth, as soon as they have cooled so that any fat splashes are removed.

After use wipe the rest of the appliance over with a cloth wrung out in liquid detergent. Do not use abrasive scourers or steel wool on any stainless steel or painted surfaces.

Always wait until the oven is cool before cleaning – this is particularly important where the glass oven door is concerned. From time to time it will be necessary to do a more thorough cleaning. When the operations described below are carried out the appliance should first be switched off from the electricity supply.

To remove the grease filter (upper oven)

This filter protects the fan from fat splashes; it should always be cleaned after roasting has taken place.

Unscrew the two finger nuts securing it to back wall and lift out.

Wash carefully, replace, and tighten the finger nuts.

As it is stainless steel you can safely wash it in a dishwasher.

To remove and clean the panels in the upper oven

If any build-up of deposit appears on the oven lining panels they should be removed for a more thorough cleaning.

To do this:

slide out the oven roof and floor panels; unclip the shelf runners by pushing up and lift off the sides;

lift the side panels off their support pins; remove the screws holding the back panel in position and lift it out.

Wash the panels with very hot water

and a detergent using a soft cloth.

If the shelf support or panels are particularly dirty then a normal caustic oven cleaner can be used.

Cleaning the lower oven

The oven interior is made of a strong vitreous enamel and therefore can be cleaned with any normal caustic oven cleaner.



Important: Please take care to follow the oven cleaner manufacturer's instructions precisely. Care must be taken to ensure that the oven cleaner does not come into contact with the aluminium and painted surfaces of the appliance.

What happens if something goes wrong

Power cuts

Should the electricity supply fail for any reason remember to reset the electronic clock to the right time when the power is resumed.

Important:

If the ovens do not come on when cooking manually, first check that the fault is with both ovens – it may be that if it is the upper one only that is affected there is probably a simple answer – the programmer is set to automatic – to set it to manual turn the control knob  to the  position.

If this is not the answer then:

check that the appliance is connected correctly;

check that the switch from the supply to the appliance is ON;

replace the fuse in the socket, where present, with another of the appropriate rating;

check that the fuse in the fuse box is intact.

If after all these checks the appliance still does not work, call your local Zanussi Network service centre listed in the telephone directory. It helps to jot down the address and telephone number in the space below.

ZANUSSI GUARANTEE CONDITIONS

This guarantee is in addition to your statutory and other legal rights which will not be excluded or in any way diminished by the return of the enclosed card.

We, IAZ International (UK) Ltd, guarantee that if within twelve months of the date of the purchase, this ZANUSSI appliance or any part thereof is proved to be defective by reason only of faulty workmanship or materials we will at our option repair or replace the same **FREE OF ANY CHARGE** for labour, materials or carriage on condition that:

- The appliance has been correctly installed and used only on the electricity supply stated on rating plate.
- The appliance has been used for normal domestic purposes and in accordance with the manufacturer's operating and maintenance instructions.
- The appliance has not been serviced, maintained, repaired, taken apart or tampered with by any person not authorised by us.

- The appliance is still in the possession of the original purchaser.
- Any appliance or defective part replaced shall become our property.

This guarantee does not cover any damage caused during transportation or the replacement of any light bulbs or removable parts of glass or plastic.

Should you require service on your Zanussi appliance consult the enclosed list for your nearest Zanussi network centre. If the product is under first year guarantee then you will be required to produce proof of date of purchase to the engineer. If it is under 5 year cover then you must show your cover card to the engineer.

Please ensure that the enclosed pre-addressed card is stamped, completed in full and forwarded to IAZ International (UK) Ltd, to enable the guarantee to be recorded. Also complete the space below as your own record of the guarantee.

GUARANTEE RECORD

Appliance purchased from _____ on _____
Guarantee card no _____ Model no _____
Serial no _____ (These details may be taken from your Guarantee Record Card)
Your name _____
Address _____
